

Landing 1
ART.3111

Landing 2
ART.3111

Loft
ART.3111

Kitchen
ART.3102G

ART.512A
EXTENSION SOUNDER

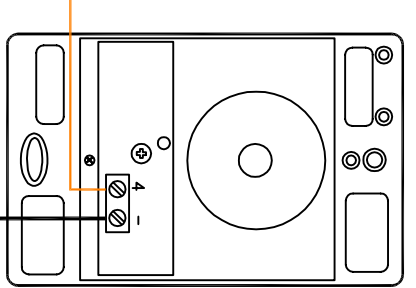
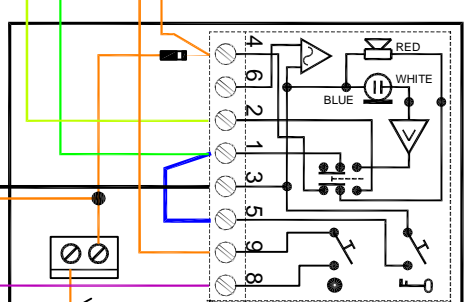
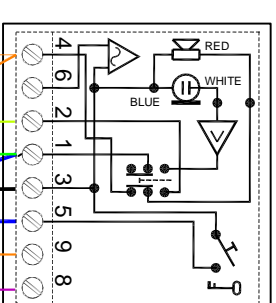
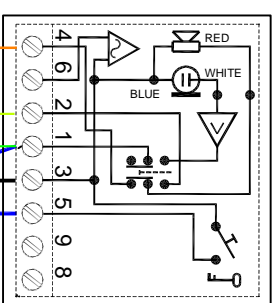
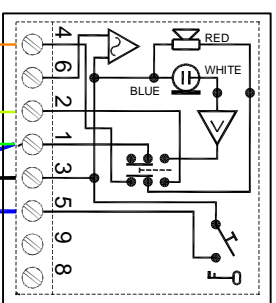

Gate override switch will enable/disable the extension sounder

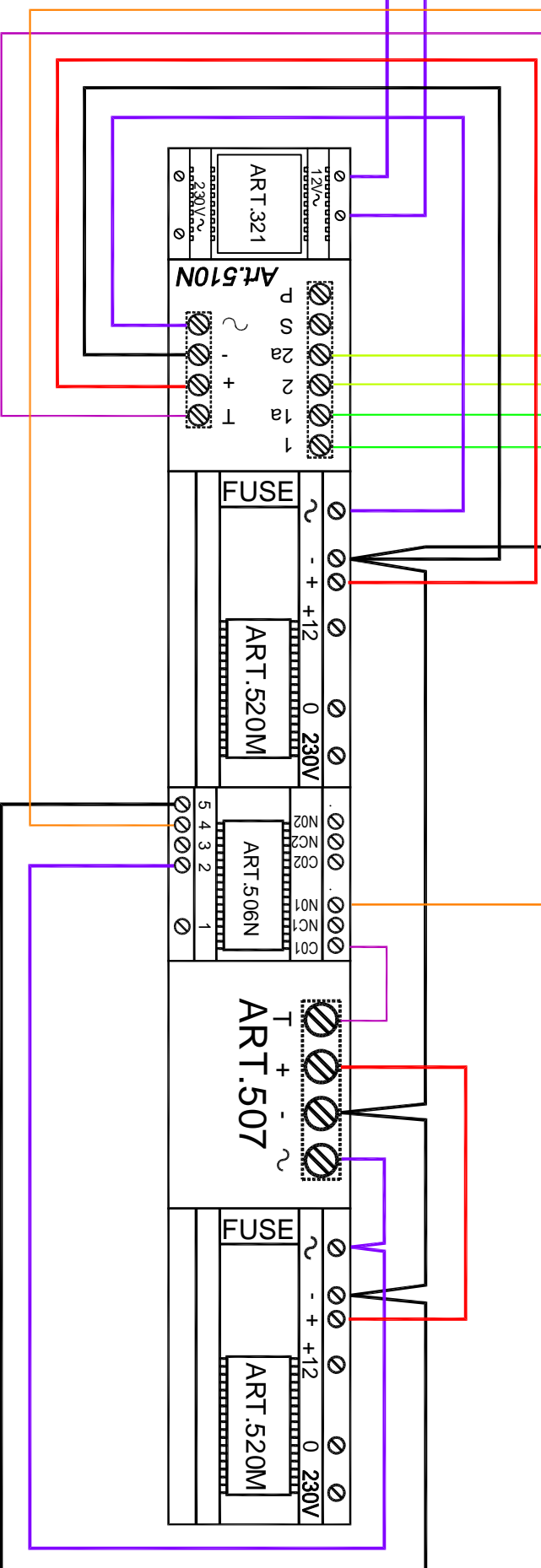
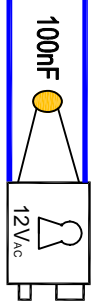
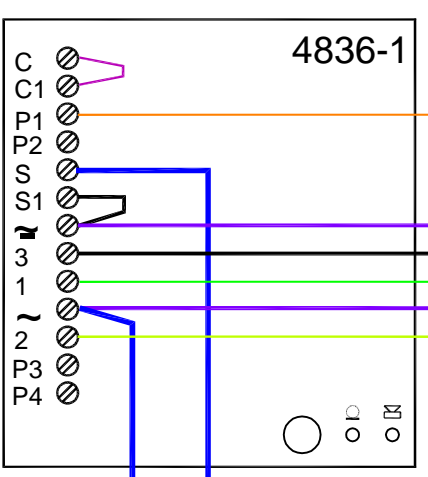

VIDEX SECURITY LTD

TECHNICAL HELP: TEL: 0191 224 3174
FAX: 0191 224 4938

EMAIL: tech@videx-security.com

DATE: 02/06/10 INITIAL: KB REF: A4836ID1B3x31011x3102G512A51C

DESCRIPTION: 4000 SERIES AUDIO & INTERCOMMUNICATION