



CDVI

31. av. du Gal Leclerc
93500 PANTIN FRANCE
Tel : 33 (0)1 48 91 01 02
Fax : 33 (0)1 48 91 21 21
www.cdvi.com

GALEO/W

ILLUMINATED ONLINE KEYPAD
26 BIT OUTPUT FORMAT, CLOCK &
DATA and CDVI OUTPUT FORMAT

IP 64 DM



I N S T A L L A T I O N M A N U A L

CABLE	Description
Red	12V DC (+)
Black	0V
Brown	Buzzer command input
Green	Data 0
White	Data 1
Blue	Clock
Gray	0V common

MOUNTING KIT

Qty	Description	Photo	Utilisation
1	M4x10 tamper screw		GALEO Mounting screw
1	T20 spanner		For the M4x10 screw
4	M4x30 mounting screws		2 * keypad back plate 2 * Remote Controller
2	Caps		GALEO cap
4	S5 plastic anchor		2 * keypad back plate 2 * Remote Controller
1	05D 680K varistor		For the lock
2	Wiring sealed caps		Cable to the controller

Dimensions: 110 x 75 x 15 mm

I. GENERAL INFORMATION

A. Description

Input voltage 12V DC
 12-digit illuminated keypad keys
 EEPROM memory storage
 User code in 4, 5 or 6 digits
 Buzzer
 ST1 jumper for programming

B. Default values

Illumination duration: 10 seconds
 User code length: 5 digits
 26 bit wiegand output
 Buzzer disabled

C. Audible Signal

1 short beep	keypad powered and key presses
1 long beep	data computing in programming
2 short beeps	Entry or Exit from programming
4 short beeps	data computing error

D. Code Length

The user code must be in 4, 5 or 6 digits.
 All the keypad keys can be used to program a user code except the B key.

Enter the user code and then B to validate the code.

E. Consumption

80mA in 12 VDC (permanent illuminated keys)

II. PROGRAMMING

A. Entry in programming

1. Turn off the power. Put the switch to ON. Put back the power.
2. Two beeps are emitted to confirm entry in programming.

The command control of the buzzer is not possible in programming mode.

B. Illumination duration

1. Enter in programming.
2. Enter A0 to program the illumination duration. One beep is emitted. Enter the time in seconds - 10 for 10 seconds to 99 for 99 seconds or enter 00 for a permanent illumination. One beep is emitted to confirm the illumination duration.

A0

3. Remove the ST1 jumper. Two beeps are emitted to confirm exit from programming.

C. Output format

1. Enter in programming.
2. Press A1 to enter in the output format menu. One beep is emitted.

A1

Press 1 to select 26-bit wiegand output format
Press 2 to select CDVI output format
Press 3 to select ISO Track 2 output format

One beep is emitted to confirm programming.

3. Remove the ST1 jumper. Two beeps are emitted to confirm exit from programming.

C. Code length

1. Enter in programming mode.
2. Press A2 to enter in the code length setting menu. One beep is emitted. Press 4 for a 4-digit user code, press 5 for a 5-digit user code or press 6 for a 6-digit user code. One beep is emitted to confirm programming.
3. Remove the ST1 jumper. Two beeps are emitted to confirm exit from programming.
4 beeps indicate a data computing error.

A2

D. Audible signal

The audible signal is always enabled in programming mode.

In factory default, the buzzer is disabled when pressing a key. To enable the buzzer:

1. Enter in programming mode.
2. Press A3. One beep is emitted. Press 0 to disable the audible signal. Press 1 to enable the audible signal. One beep is emitted to confirm programming.
3. Remove the ST1 jumper. Two beeps are emitted to confirm exit from programming.

A3

E. External control of the buzzer

The buzzer can be activated from an external input. The control is done with a logic signal on the input.

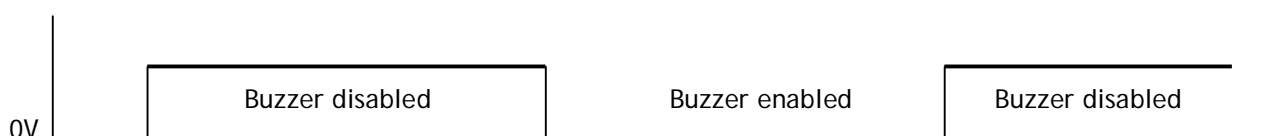

F. 26-bit wiegand format

Chronograms

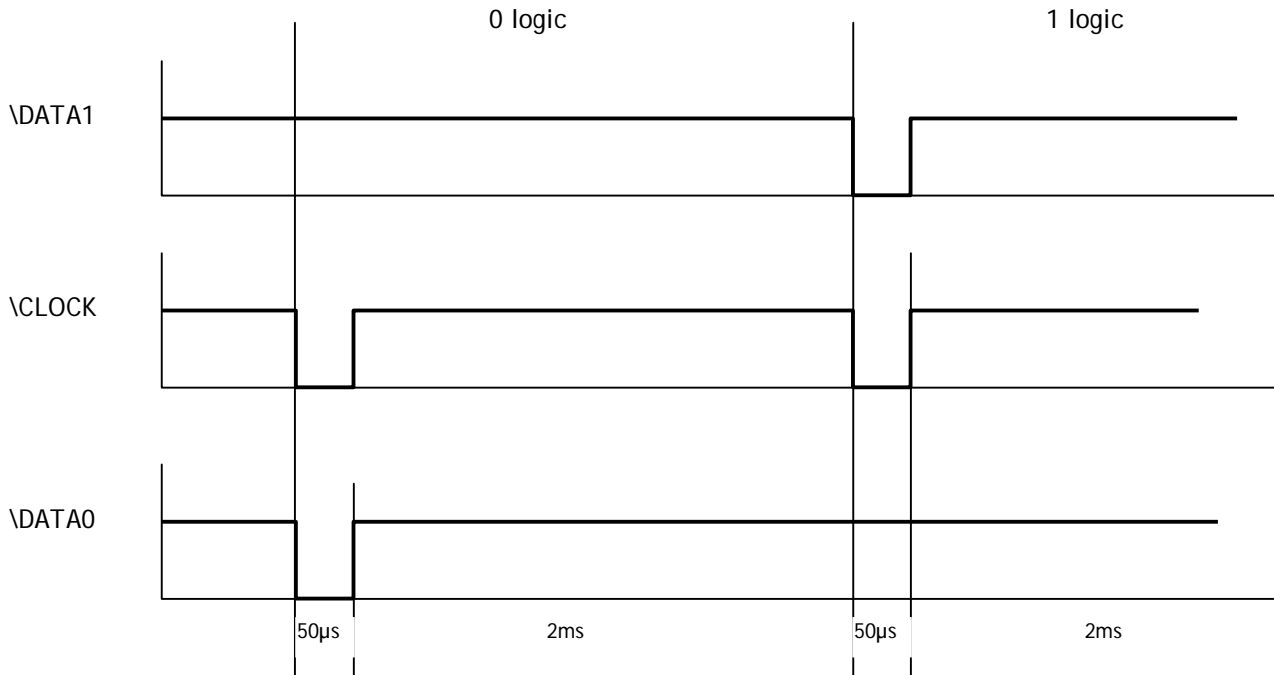

Interfaçage

The output format is 26-bit **Wiegand** (Signals: DATA1, DATA0 and CLOCK)
 Output signal in open collectors (pull up of 2.2K in +5V)
 26-bit hexadecimal output format

The frame is made of 26-bit and built as follow:
First parity: 1-bit - even parity for the first 12-bit
User Code: 3 half of a byte represent the code entered
 Each byte is transferred from bit 7 to bit 0.
Second parity: 1-bit - odd parity for the last 12-bit

Bit 1	Bit 2 ... bit 25	bit 26
Even parity on bit 2...bit13	Data (24 bits)	Odd parity on bit 14...bit 25

Example a 4-digit code: 1350 then B

1	0000	0000	0001	0011	0101	0000	1
Parity 1	0	0	1	3	5	0	Parity 2

The code is transmitted in hexadecimal: 001350

Example a 5-digit code: 71350 then B

0	0000	0111	0001	0011	0101	0000	1
Parity 1	0	7	1	3	5	0	Parity 2

The code is transmitted in hexadecimal: 071350

Example a 6-digit code: 671350 then B

0	0110	0111	0001	0011	0101	0000	1
Parity 1	6	7	1	3	5	0	Parity 2

The code is transmitted in hexadecimal: 671350

Parity 1: 0 if the number of 1 in bit 2 to bit 13 is even
 1 if the number of 1 in bit 2 to bit 13 is odd

Parity 2: 0 if the number of 1 in bit 14 to bit 25 is odd
1 if the number of 1 in bit 14 to bit 25 is even

G. CDVI Format

This format is owned by CDVI. This format is compatible with other CDVI products (PROMI, UCA3).

H. ISO 7811 Track 2 Format

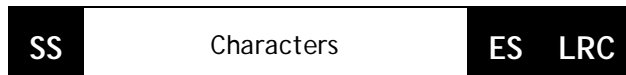

SS = start sentinel Hex B
ES = end sentinel Hex F
LRC = Ou Exclusif de tous les caractères de la trame (including SS and ES)

The code length is set at 8 digits:

In 4 digits - 00001234

In 5-digits - 00012345

In 6-digits - 00123456

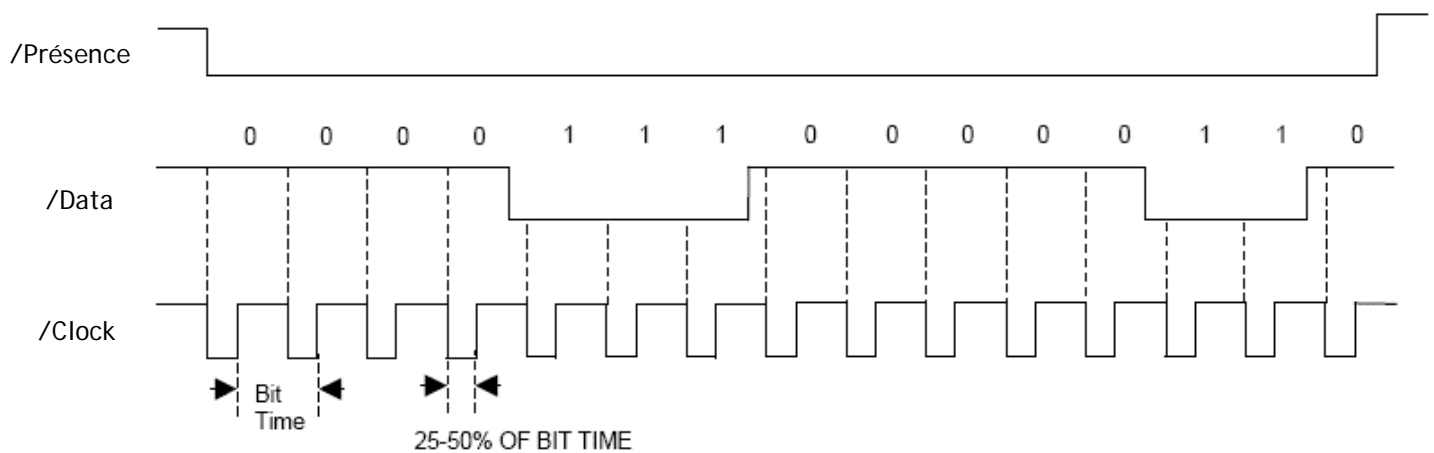

Each digit is made of 5 bits (4 bits data + 1 bit parity)

Characters	B4	B3	B2	B1	Parity
0	0	0	0	0	1
1	0	0	0	1	0
2	0	0	1	0	0
3	0	0	1	1	1
4	0	1	0	0	0
5	0	1	0	1	1
6	0	1	1	0	1
7	0	1	1	1	0
8	1	0	0	0	0
9	1	0	0	1	1
A	1	0	1	0	1
B = SS	1	0	1	1	0
C	1	1	0	0	1
D = FD	1	1	0	1	0
E	1	1	1	0	0
F = ES	1	1	1	1	1

III. MOUNTING INSTRUCTIONS

- 1 Drill (bit Ø5mm) 2 mounting holes (minimum depth 35mm) and the cable hole.

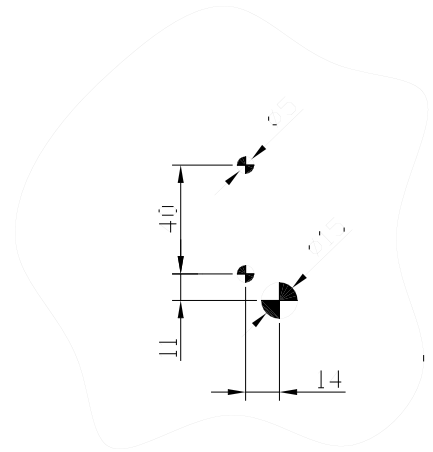

- 2 Insert the S5 2 plastic anchors in the holes. Mount the back plate with the M4x30 screws.

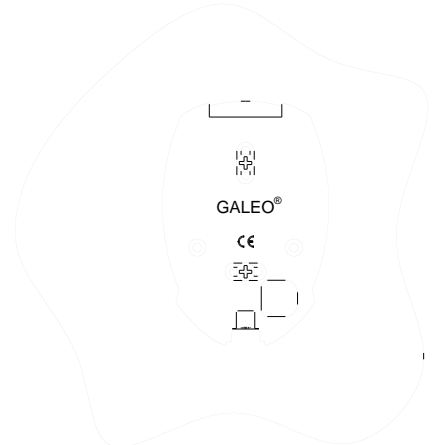

- 3 Insert the cable of the GALEO® inside to cable hole. Place the GALEO® on the back plate and slide it from up to down. Make sure that the mounting bracket is properly set with the GALEO.

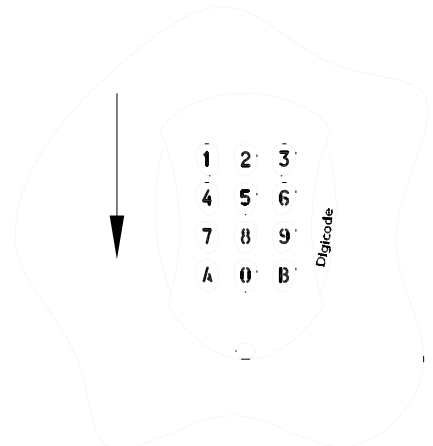

- 4 Use the M4x10 screw to close the keypad (T20 spanner). Place the screw cap.

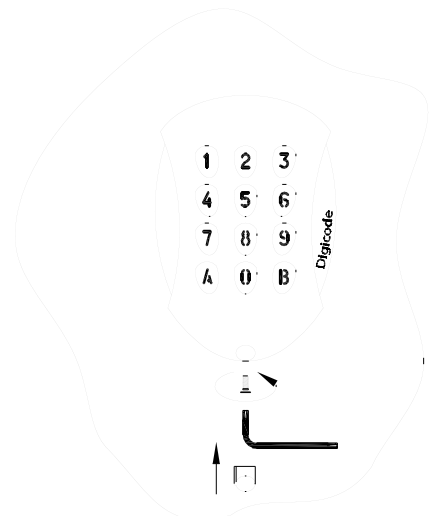

- R To mount the remote controller on the wall use the plastic bracket.